

PowerCommand™

Digital Generator Set Control

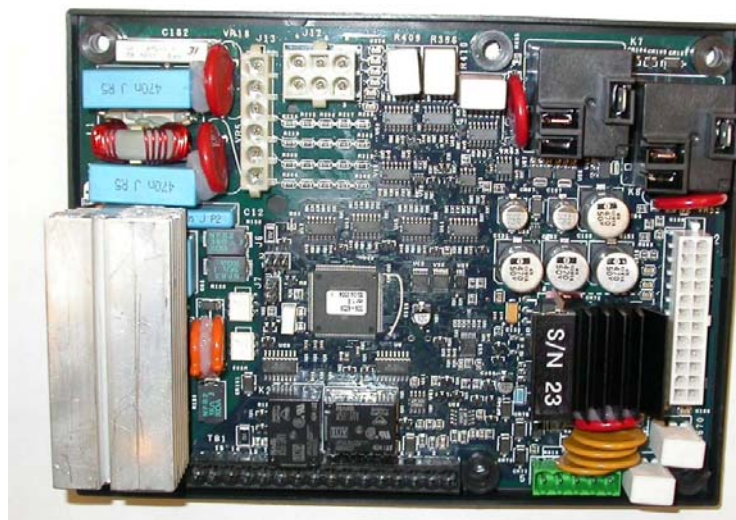

Description

The PowerCommand™ (1301) Control is a microprocessor-based generator set monitoring, metering, and control system. The control provides a simple operator interface to the generator set, digital voltage regulation (optional AVR-Enable/Disable), digital engine speed governing (optional Electronic Governor –Enable/Disable), start / stop control, 12V/24V battery operation and generator set protective functions. The integration of all functions into a single control system provides enhanced reliability and performance compared to conventional generator set control systems.

The PowerCommand™ 1301 generator set control is suitable for use on a wide range of generator sets in non-paralleling applications. The PowerCommand™ Control is compatible with reconnectable alternators up to 480VAC line to line, and can be configured for any frequency, voltage, and power connection configuration from 120-480VAC line to line.

The PowerCommand™ 1301 is designed for mounting on the generator set.

Power for the control is derived from the generator set starting batteries. The control functions over a voltage range from 8VDC to 30 VDC.

The control offers a wide range of standard control and optional display panel features so custom control configurations are not needed to meet application specifications.

Features

- **12 VDC/24 VDC Battery Operation.**
- **Digital Voltage Regulation** (optional - AVR Enable/Disable).
- **Digital Engine Speed Governing** (optional – Electronic Governor- Enable/Disable) to provide isochronous frequency regulation.
- **Single or 3 Phase Voltage and Current Sensing.** Wye and delta voltage sensing. Current sensing with external 5 Amp current transformers.
- **Engine Starting** includes relay drivers for start, fuel shut off (FSO), and glow plug. Start disconnect is achieved by monitoring the battery charging alternator.
- **Generator Set Monitoring.** Monitors status of all critical engine and alternator conditions functions.
- **Generator Set Protection.** Engine and alternator.
- **Operator Display Panel** (optional). Provides easy to use symbolic operator display of critical generator set parameters and operating history.
- **Advanced Serviceability** using InPower™, a PC-based software service tool.
- **Environmental Protection.** The control system is designed for reliable operation in harsh environments. The core control board is an encapsulated module that is fully protected from the elements.
- **Configurable Inputs and Outputs.** Two discrete inputs and two dry contact relay outputs.

- **Certifications.** Suitable for use on generator sets that are designed, manufactured, tested, and certified to relevant UL, NFPA, ISO, IEC, Mil Std. and CE standards.
- **Warranty and Service.** Backed by a comprehensive warranty and worldwide distributor service network.

Control System

The standard control system includes a control board with an external control switch and status indicator. The control board includes all functions necessary to locally or remotely start and stop, regulate voltage, and protect the generator set.

Control Switch - RUN/OFF/AUTO - In the OFF mode the generator set is immediately shut down (if running) and cannot be started. In the RUN mode the generator set will execute its start sequence, and operate at rated speed and voltage. In the AUTO mode, the generator set can be started with a start signal from a remote device, such as an automatic transfer switch. The fault/status lamp will flash until the generator set is at rated speed and voltage. Operation of the switch to the OFF position also resets faults in the control.

Status Indications - The control includes a lamp driver for an external fault/status indication. When this feature is used, it provides the operator with basic status information on the generator set. Functions displayed include:

- The lamp flashes during preheat (when used) and while the generator set is starting.
- The lamp indicates “READY TO LOAD” by flashing until the generator set is at rated voltage and frequency, then turning on continuously.
- Fault conditions are displayed by flashing a two-digit fault code number.

Optional Engine Speed Governing

The control is available with an optional governor power stage. This power stage amplifies control signals to directly drive an engine fuel control valve.

Optional Display Panel

The control is available with an optional display panel that may be either locally or remotely mounted. The operator screens are made up of internationally accepted symbols, so translations are not required. The display is composed of a backlit LCD display, with a series of 6 generator status LED lamps. The display is accompanied by six tactile feel membrane switches that are used by the operator to navigate through control menus, and to make control adjustments. (There are no rotary potentiometers in the control. All adjustments are made via the display panel or InPower.) It is configurable for units of measurement. It is adjustable for screen contrast and brightness.

The Run/Off/Auto switch function is integrated into the display panel; therefore an external switch is not required with the display panel option.

All data on the control can be viewed by scrolling through screens with the navigation keys.

The control displays current active faults, and a time-ordered history of previous faults.

LED Indicating Lamps - The optional display panel includes LED indicating lamps for the following functions:

Not in Auto
Shutdown
Warning
Remote Start
Auto
Run

Operator Adjustments - The optional display panel includes provisions for many set up and adjustment functions via raise/lower switches. Functions that can be adjusted by the operator include:

Time delay start (0-300 seconds)
Time delay stop (0-600 seconds)
Alternator voltage (plus or minus 5%)



Generator Set Hardware Data - Access to the control and software part number, generator set rating in KVA, and generator set model number is provided from the optional display panel or InPower.

Data Logs - Engine run time, controller on time, number of runs, and number of start attempts are available from the optional display panel or through InPower.

Fault History - Provides a record of the most recent fault conditions with control hours time stamp. Up to 5 events are stored in the control non-volatile memory.

Alternator Data

- Voltage (single or 3 phase Line-Line and Line-Neutral)
- Current (3 phase)
- KVA
- Frequency

Engine Data

- Starting Battery Voltage
- Engine Speed
- Engine Temperature
- Engine Oil pressure

Service Adjustments - The operator panel includes provisions for adjustment and calibration of generator set control functions. Adjustments are protected by a password. Functions include:

- Engine speed governor adjustments
- 12 VDC/24 VDC battery operations
- Voltage regulation adjustments
- Cycle cranking
- Configurable fault set up
- Configurable output set up
- Meter calibration
- Display language and units of measurement

Other Information -

- Control Not Communicating
- Pop-up Timers to indicate time remaining on time delays in the system.

Internal Control Functions

Engine Control

12 VDC/24VDC Battery Operations – Power Command will operate either on 12 VDC or 24 VDC batteries.

Isochronous Governing – (optional Electronic Governor Enable/Disable) Controls engine speed within plus or minus 0.25% for any steady state load from no load to full load. Frequency drift will not exceed plus or minus 0.5% for a 60F (33C) change in ambient temperature over an 8 hour period.

Temperature Dependent Governing Dynamics – (with governing option) Modifies the engine governing control parameters as a function of engine temperature. Allows engine to be more responsive when warm, and more stable when operating at lower temperature levels.

Remote Start Mode - Power Command 1301 accepts a ground signal from remote devices to automatically start the generator set and immediately accelerate to rated speed and voltage.

The control can incorporate a time delay start.

Remote Emergency Stop – The control accepts a ground signal from an external emergency stop switch to cause the generator set to immediately shut down. The generator set is prevented from running or cranking with the switch engaged.

Sleep Mode -The control is configured to include a sleep mode. When the mode select switch is in the OFF position, the control will revert to a low-power-consumption mode until the Run/Off/Auto control switch or any button on the optional display panel is operated.

Engine Starting - The control system supports automatic engine starting, including a 30 amp relay contact for the starter motor and fuel shutoff. Primary and backup start disconnects are achieved by one of three methods, magnetic pickup, battery charging alternator feedback, or main alternator output frequency. The control also supports programmable glow plug control. This feature can be disabled when not required.

Cycle Cranking - Configurable for number of starting cycles (1 to 7) and duration of crank and rest periods. Control includes starter protection algorithms to prevent the operator from specifying a starting sequence that might be damaging.

Time Delay Start and Stop (Cooldown) - Configurable for time delay of 0-300 seconds prior to starting after receiving a remote start signal, and for time delay of 0-600 seconds prior to ramp to idle or shut down after signal to stop in normal operation modes. Default for both time delay periods is 0 Sec.

Alternator Control

Power Command 1301 includes an integrated line-to-line sensing voltage regulation system that is

compatible with shunt excitation systems. The voltage regulation system is full wave rectified and has a SCR output for good motor starting capability. Major system features include:

Digital Output Voltage Regulation (Optional – AVR Enable/Disable) - Power Command 1301 will regulate output voltage to within 0.5% for any loads between no load and full load if AVR enabled feature is enabled. Voltage drift will not exceed plus or minus 0.5% for a 60F (33C) change in temperature in an 8 hour period. On engine starting, or sudden load acceptance, voltage is controlled to a maximum of 5% overshoot over nominal level.

Torque-Matched Volts/Hz Overload Control - The voltage roll-off set point and rate of decay (i.e., the slope of the Volts/Hertz curve) is adjustable in the control.

Protective Functions

On operation of a protective function the control will indicate a fault by flashing the fault code on the status LED on the base control board. On systems with an optional display panel, the warning or shutdown LED will light and fault symbol, name, and code will be indicated. The nature of the fault and time of occurrence are logged in the control. The service manual and InPower service tool provide service keys and procedures based on the service codes provided.

PowerCommand™ provides the following system protective functions:

- **Configurable Alarm and Status Inputs** –Power Command 1301 will accept up to two alarm or status inputs (configurable contact closed to ground or open) to indicate customer-specified conditions. The control is programmable for warning, shutdown or status indication, and for labeling the input.
- **Emergency Stop** - Annunciated whenever the emergency stop signal is received from external switch.

Engine Protection

- **Overspeed Shutdown** - Default setting is 115% of nominal.
- **Low Lube Oil Pressure Warning/Shutdown** - Level is preset (configurable with InPower) to match the capabilities of the engine used. Control includes time delays to prevent nuisance shutdown signals.
- **High Engine Temperature Warning/Shutdown** - Level is preset (configurable with InPower) to match the capabilities of the engine used. Control includes time delays to prevent nuisance shutdown signals.
- **Low Coolant Temperature Warning** - Indicates that engine temperature may not be high enough for a 10-second start or proper load acceptance.

- **Low and High Battery Voltage Warning** - Indicates status of battery charging system (failure) by continuously monitoring battery voltage.
- **Weak Battery Warning** - The control system will test the battery each time the generator set is signaled to start, and indicate a warning if the battery indicates impending failure.
- **Fail to Start (Overcrank) Shutdown**
- **Fail to Crank Shutdown** - Control has signaled starter to crank engine but engine does not rotate.
- **Cranking Lockout** - The control will not allow the starter to attempt to engage or to crank the engine when the engine is rotating.
- **Sensor Failure Indication** - Logic is provided on the base control to detect analog sensor or interconnecting wiring failures.

Alternator Protection

- **High/Low AC Voltage Shutdown** - High default to 110% for 10 seconds, instantaneous 130%. Low default to 85% for 10 seconds
- **Overcurrent Warning/Shutdown** - Warning default to 110% for 60 seconds. Shutdown default to 150% for 10 seconds.
- **Under/Over Frequency** - Under default to -6Hz for 10 seconds. Over default +6Hz for 10 seconds.
- **Loss Of Sensing Voltage Shutdown**
- **Field Overload Shutdown**

Environment

The control is designed for proper operation without recalibration in ambient temperatures from –40 Deg C to +70 Deg C, and for storage from –55Deg C to +80 Deg C. Control will operate with humidity up to 95%, non-condensing.

The optional display panel is designed for proper operation in ambient temperatures from –20 Deg C to +70 Deg C, and for storage from –30 Deg C to +80 Deg C

The control board is fully encapsulated to provide superior resistance to dust and moisture. The optional display panel has a single membrane surface, which is impervious to effects of dust, moisture, oil, and exhaust fumes. This panel uses a sealed membrane to provide long reliable service life in harsh environments.

The control system is specifically designed and tested for resistance to RFI/EMI, and to resist effects of vibration to provide a long reliable life when mounted on a generator set. The control includes transient voltage surge suppression to provide compliance to referenced standards.

Certifications

PowerCommand™ meets or exceeds the requirements of the following codes and standards:

- **NFPA110** for Level 2 or 3 systems.
- **ISO 8528-4: 1993 Compliance**, Controls and Switchgear
- **CE Marking**: The control system is suitable for use on generator sets to be CE-marked.
- **EN 50081-1,2** Residential/Light Industrial emissions, or Industrial Emissions
- **EN 50082-1,2** Residential/Light Industrial or Industrial susceptibility
- **ISO 7637-2, level 2**; DC supply surge voltage test.
- **Mil Std 202C, Method 101 and ASTM B117**: Salt Fog test

PowerCommand™ control systems and generator sets are designed and manufactured in ISO9001 certified facilities. The control is suitable for use on generator sets that are UL 2200 listed.

Software

InPower

InPower (beyond 4.5 version) is a PC-based software service tool that is designed to directly communicate to PowerCommand™ generator sets and transfer switches, to facilitate service and monitoring of these products.

PowerCommand™ for Windows

PowerCommand™ for Windows is a software tool that is used primarily by operators to remotely monitor and control generator sets, transfer switches, and other on-site power system devices.

Control Interface

Input signals to the base control include:

- **Run/Off/Auto Switch** - Required when the optional display panel is not used.
- **Generator Set Status Lamp**

- **Remote Start Signal**
- **Remote Emergency Stop**
- **Configurable Inputs** - Control includes (2) input signals from customer discrete devices that are configurable for warning, shutdown, or status indication, as well as message displayed.

Output signals from the PowerCommand™ control include:

- **Configurable relay outputs** - Control includes (2) relay outputs rated at 2 amps. These outputs can be configured to activate on any control warning or shutdown fault as well as ready to load, not in auto, common alarm, common warning, and common shutdown.
- **Ready to Load (generator set running) signal** - Operates when the generators set has reached 90% of rated speed and voltage and latches until generator set is switched to off or idle mode. (B+ signal output).

Communications connections include:

- **PC Tool Interface** - This RS-485 communication port is to allow the control to communicate with a personal computer running InPower or PowerCommand™ for Windows software. Also this RS-485 port is to allow the control to communicate with external devices like PLC on MODBUS protocol.
Note – A RS-232 to RS-485 Converter is required for communication between PC to Control.
- **Networking** - This RS-485 communication port is to allow connection from the control to the other Cummins Power Generation products.

Options and Accessories

Display Panel - Provides a local or remote operator display of engine and alternator. Includes set up and generator set history information.

Mechanical Drawings

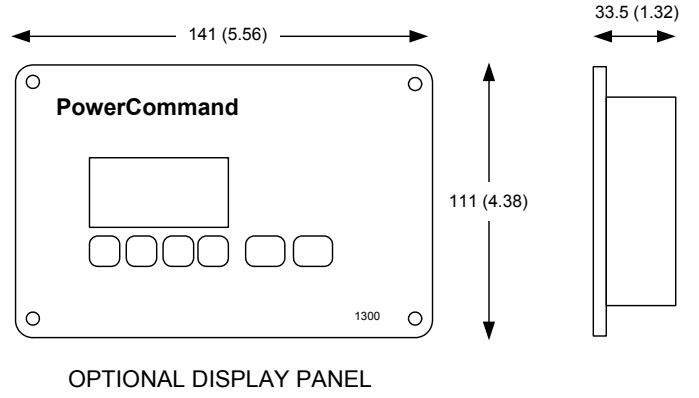
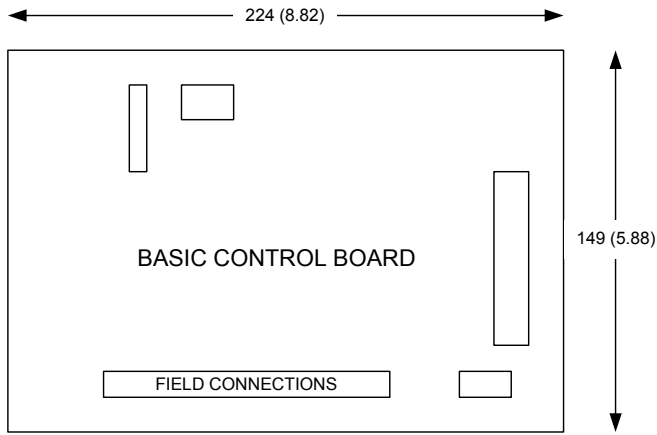

Dimensions: mm (inches)

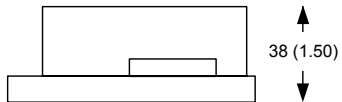
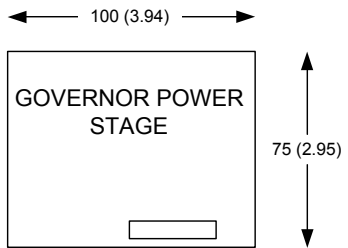
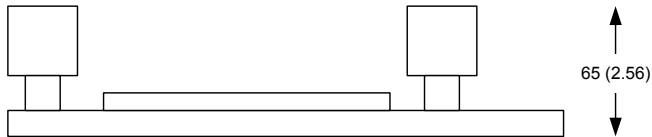

Electrical Interconnections

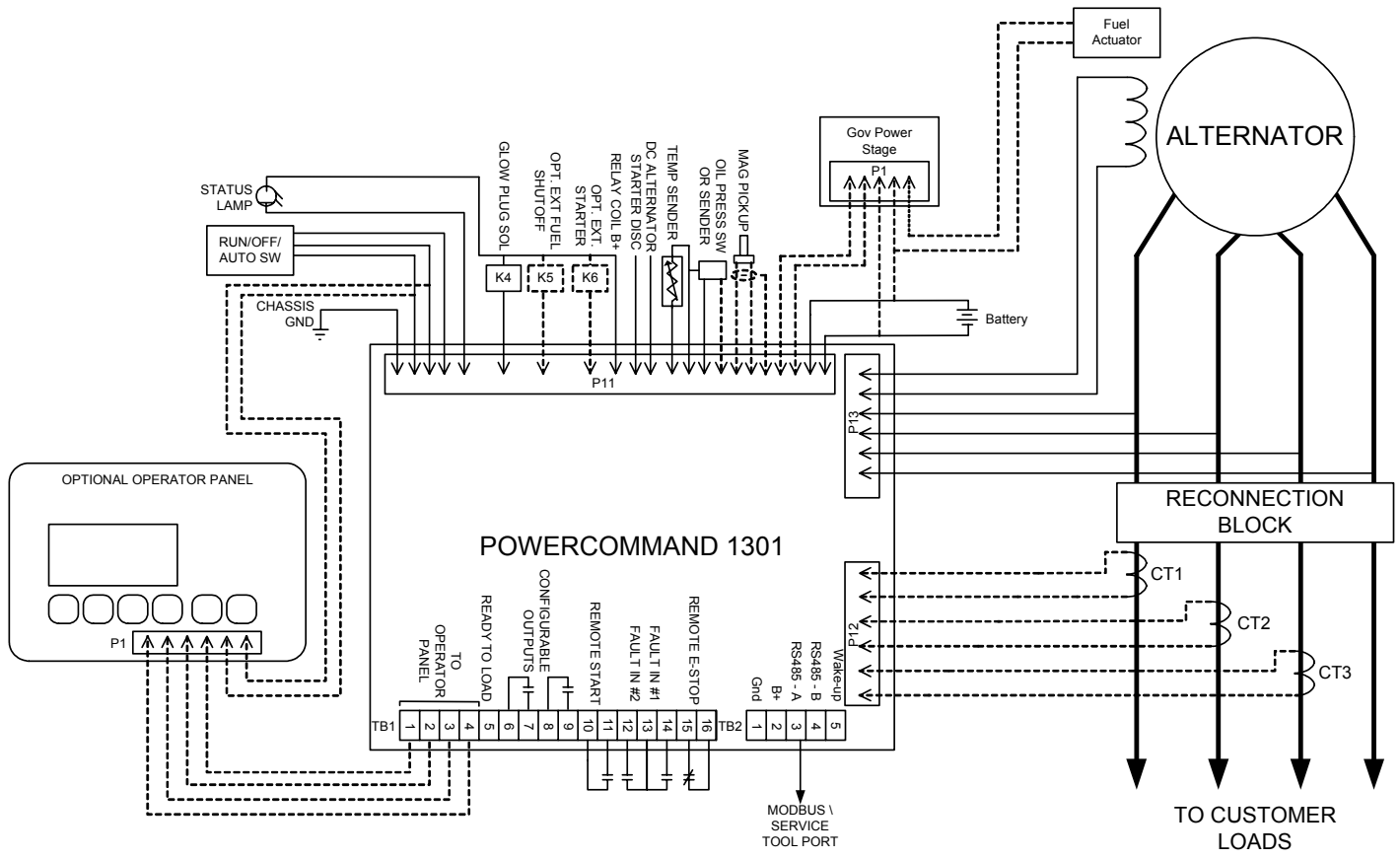

Warranty

All components and subsystems are covered by an express limited one-year warranty. Other optional and extended factory warranties and local distributor maintenance agreements are available. Contact your distributor/dealer for more information.

Certifications



ISO9001 - This product set was designed and manufactured in facilities certified to ISO9001.



PTS - The Prototype Test Support (PTS) program verifies the performance integrity of a generator set design. Products bearing the PTS symbol have been subjected to demanding tests in accordance to NFPA 110 to verify the design integrity and performance under both normal and abnormal operating conditions.



UL - The control is suitable for use on generator sets that are listed to UL2200, Stationary Engine Generator Assemblies.



CE - This product is suitable for use on generator sets that are CE marked.

See your distributor for more information



Cummins Power Generation
1400 73rd Avenue N.E.
Minneapolis, MN 55432
763.574.5000
Fax: 763.574.5298
www.cumminspowergeneration.com

Cummins and PowerCommand™ are registered trademarks of Cummins Inc.
InPower and AmpSentry are trademarks of Cummins Inc.

Important: Backfeed to a utility system can cause electrocution and/or property damage. Do not connect generator sets to any building electrical system except through an approved device or after building main switch is open.